



256K x 16 Static RAM

Features

- High speed
 - $t_{AA} = 12 \text{ ns}$
- Low active power
 - 1540 mW (max.)
- Low CMOS standby power (L version)
 - 2.75 mW (max.)
- 2.0V Data Retention (400 μW at 2.0V retention)
- Automatic power-down when deselected
- TTL-compatible inputs and outputs
- Easy memory expansion with $\overline{\text{CE}}$ and $\overline{\text{OE}}$ features

Functional Description

The CY7C1041B is a high-performance CMOS static RAM organized as 262,144 words by 16 bits.

Writing to the device is accomplished by taking Chip Enable (CE) and Write Enable (WE) inputs LOW. If Byte Low Enable

(BLE) is LOW, then data from I/O pins (I/O₀ through I/O₇), is written into the location specified on the address pins (A₀ through A₁₇). If Byte High Enable (BHE) is LOW, then data from I/O pins (I/O₈ through I/O₁₅) is written into the location specified on the address pins (A₀ through A₁₇).

Reading from the device is accomplished by taking Chip Enable (CE) and Output Enable (OE) LOW while forcing the Write Enable (WE) HIGH. If Byte Low Enable (BLE) is LOW, then data from the memory location specified by the address pins will appear on I/O₀ to I/O₇. If Byte High Enable (BHE) is LOW, then data from memory will appear on I/O₈ to I/O₁₅. See the truth table at the back of this data sheet for a complete description of read and write modes.

The input/output pins (I/O₀ through I/O₁₅) are placed in a high-impedance state when the device is deselected ($\overline{\text{CE}}$ HIGH), the outputs are disabled (OE HIGH), the BHE and BLE are disabled (BHE, BLE HIGH), or during a write operation (CE LOW, and WE LOW).

The CY7C1041B is available in a standard 44-pin 400-mil-wide body width SOJ and 44-pin TSOP II package with center power and ground (revolutionary) pinout.

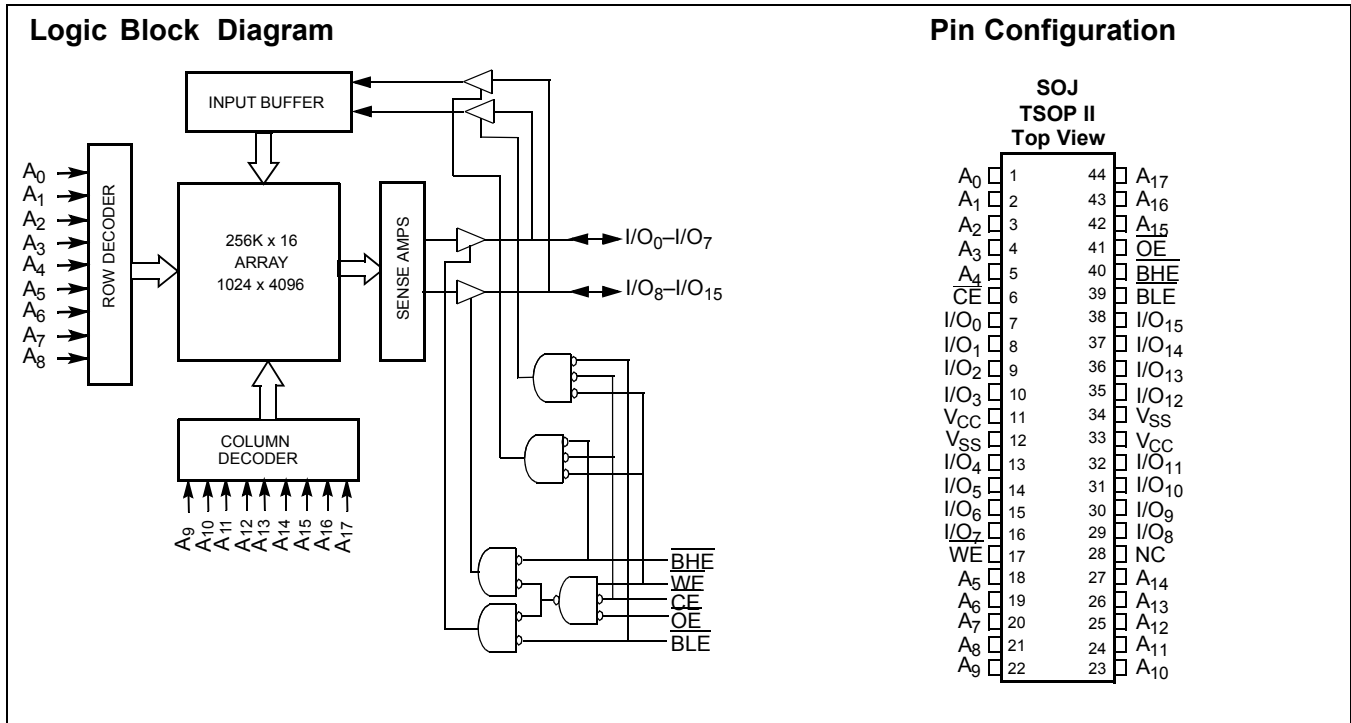

Selection Guide

| | | 7C1041B-12 | 7C1041B-15 | 7C1041B-17 | 7C1041B-20 | 7C1041B-25 | Unit |
|------------------------------|-------|------------|------------|------------|------------|------------|------|
| Maximum Access Time | | 12 | 15 | 17 | 20 | 25 | ns |
| Maximum Operating Current | Com'l | 200 | 190 | 180 | 170 | 160 | mA |
| | Ind'l | 220 | 210 | 200 | 190 | 180 | |
| Maximum CMOS Standby Current | Com'l | 3 | 3 | 3 | 3 | 3 | mA |
| | Com'l | L | 0.5 | 0.5 | 0.5 | 0.5 | |
| | Ind'l | - | 6 | 6 | 6 | 6 | |

Maximum Ratings

(Above which the useful life may be impaired. For user guidelines, not tested.)

Storage Temperature -65°C to +150°C

Ambient Temperature with Power Applied -55°C to +125°C

Supply Voltage on V_{CC} to Relative GND^[1] -0.5V to +7.0V

DC Voltage Applied to Outputs in High Z State^[1] -0.5V to V_{CC} + 0.5V

DC Input Voltage^[1] -0.5V to V_{CC} + 0.5V

Current into Outputs (LOW) 20 mA

Operating Range

| Range | Ambient Temperature ^[2] | V _{CC} |
|------------|------------------------------------|-----------------|
| Commercial | 0°C to +70°C | 5V ± 0.5 |
| Industrial | -40°C to +85°C | |

Electrical Characteristics Over the Operating Range

| Parameter | Description | Test Conditions | 7C1041B-12 | | 7C1041B-15 | | 7C1041B-17 | | Unit |
|------------------|--|---|------------|-----------------------|------------|-----------------------|------------|-----------------------|------|
| | | | Min. | Max. | Min. | Max. | Min. | Max. | |
| V _{OH} | Output HIGH Voltage | V _{CC} = Min., I _{OH} = -4.0 mA | 2.4 | | 2.4 | | 2.4 | | V |
| V _{OL} | Output LOW Voltage | V _{CC} = Min., I _{OL} = 8.0 mA | | 0.4 | | 0.4 | | 0.4 | V |
| V _{IH} | Input HIGH Voltage | | 2.2 | V _{CC} + 0.5 | 2.2 | V _{CC} + 0.5 | 2.2 | V _{CC} + 0.5 | V |
| V _{IL} | Input LOW Voltage ^[1] | | -0.5 | 0.8 | -0.5 | 0.8 | -0.5 | 0.8 | V |
| I _{IX} | Input Load Current | GND ≤ V _I ≤ V _{CC} | -1 | +1 | -1 | +1 | -1 | +1 | mA |
| I _{OZ} | Output Leakage Current | GND ≤ V _{OUT} ≤ V _{CC} , Output Disabled | -1 | +1 | -1 | +1 | -1 | +1 | mA |
| I _{CC} | V _{CC} Operating Supply Current | V _{CC} = Max., f = f _{MAX} = 1/t _{RC} | Com'l | | 200 | 190 | 180 | | mA |
| | | | Ind'l | | 220 | 210 | 200 | | |
| I _{SB1} | Automatic CE Power-Down Current —TTL Inputs | Max. V _{CC} , CE ≥ V _{IH} V _{IN} ≥ V _{IH} or V _{IN} ≤ V _{IL} , f = f _{MAX} | | 40 | | 40 | | 40 | mA |
| I _{SB2} | Automatic CE Power-Down Current —CMOS Inputs | Max. V _{CC} , CE ≥ V _{CC} - 0.3V, V _{IN} ≥ V _{CC} - 0.3V, or V _{IN} ≤ 0.3V, f = 0 | Com'l | | 3 | 3 | 3 | | mA |
| | | | Com'l | | L | - | 0.5 | 0.5 | |
| | | | Ind'l | | - | 6 | 6 | | |

Notes:

- V_{IL} (min.) = -2.0V for pulse durations of less than 20 ns.
- T_A is the case temperature.

Electrical Characteristics Over the Operating Range (continued)

| Parameter | Description | Test Conditions | 7C1041B-20 | | 7C1041B-25 | | Unit |
|------------------|---|---|------------|-----------------------|------------|-----------------------|------|
| | | | Min. | Max. | Min. | Max. | |
| V _{OH} | Output HIGH Voltage | V _{CC} = Min., I _{OH} = -4.0 mA | 2.4 | | 2.4 | | V |
| V _{OL} | Output LOW Voltage | V _{CC} = Min., I _{OL} = 8.0 mA | | 0.4 | | 0.4 | V |
| V _{IH} | Input HIGH Voltage | | 2.2 | V _{CC} + 0.5 | 2.2 | V _{CC} + 0.5 | V |
| V _{IL} | Input LOW Voltage ^[1] | | -0.5 | 0.8 | -0.5 | 0.8 | V |
| I _{IX} | Input Load Current | GND ≤ V _I ≤ V _{CC} | -1 | +1 | -1 | +1 | mA |
| I _{OZ} | Output Leakage Current | GND ≤ V _{OUT} ≤ V _{CC} , Output Disabled | -1 | +1 | -1 | +1 | mA |
| I _{CC} | V _{CC} Operating Supply Current | V _{CC} = Max., f = f _{MAX} = 1/t _{RC} | Com'l | 170 | | 160 | mA |
| | | | Ind'l | 190 | | 180 | mA |
| I _{SB1} | Automatic CE Power-Down Current — TTL Inputs | Max. V _{CC} , CE ≥ V _{IH} V _{IN} ≥ V _{IH} or V _{IN} ≤ V _{IL} , f = f _{MAX} | | 40 | | 40 | mA |
| I _{SB2} | Automatic CE Power-Down Current — CMOS Inputs | Max. V _{CC} , CE ≥ V _{CC} - 0.3V, V _{IN} ≥ V _{CC} - 0.3V, or V _{IN} ≤ 0.3V, f = 0 | Com'l | 3 | | 3 | mA |
| | | | Com'l L | 0.5 | | 0.5 | mA |
| | | | Ind'l | 6 | | 6 | mA |

Capacitance^[3]

| Parameter | Description | Test Conditions | Max. | Unit |
|------------------|-------------------|---|------|------|
| C _{IN} | Input Capacitance | T _A = 25°C, f = 1 MHz, V _{CC} = 5.0V | 8 | pF |
| C _{OUT} | I/O Capacitance | | 8 | pF |

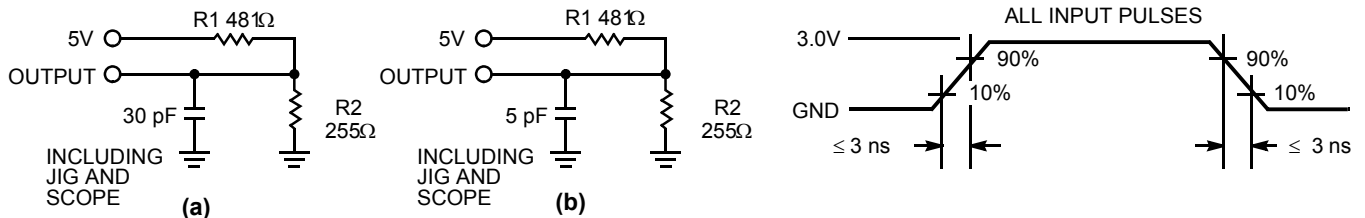
AC Test Loads and Waveforms

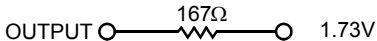
Equivalent to: THÉVENIN EQUIVALENT

Note:
 3. Tested initially and after any design or process changes that may affect these parameters.

Switching Characteristics^[4] Over the Operating Range

| Parameter | Description | 7C1041B-12 | | 7C1041B-15 | | 7C1041B-17 | | Unit |
|-------------------------------------|---|------------|------|------------|------|------------|------|---------|
| | | Min. | Max. | Min. | Max. | Min. | Max. | |
| Read Cycle | | | | | | | | |
| t_{power} | V_{CC} (typical) to the First Access ^[5] | 1 | | 1 | | 1 | | μ s |
| t_{RC} | Read Cycle Time | 12 | | 15 | | 17 | | ns |
| t_{AA} | Address to Data Valid | | 12 | | 15 | | 17 | ns |
| t_{OHA} | Data Hold from Address Change | 3 | | 3 | | 3 | | ns |
| t_{ACE} | \overline{CE} LOW to Data Valid | | 12 | | 15 | | 17 | ns |
| t_{DOE} | \overline{OE} LOW to Data Valid | | 6 | | 7 | | 7 | ns |
| t_{LZOE} | \overline{OE} LOW to Low Z | 0 | | 0 | | 0 | | ns |
| t_{HZOE} | \overline{OE} HIGH to High Z ^[6, 7] | | 6 | | 7 | | 7 | ns |
| t_{LZCE} | \overline{CE} LOW to Low Z ^[7] | 3 | | 3 | | 3 | | ns |
| t_{HZCE} | \overline{CE} HIGH to High Z ^[6, 7] | | 6 | | 7 | | 7 | ns |
| t_{PU} | \overline{CE} LOW to Power-Up | 0 | | 0 | | 0 | | ns |
| t_{PD} | \overline{CE} HIGH to Power-Down | | 12 | | 15 | | 17 | ns |
| t_{DBE} | Byte Enable to Data Valid | | 6 | | 7 | | 7 | ns |
| t_{LZBE} | Byte Enable to Low Z | 0 | | 0 | | 0 | | ns |
| t_{HZBE} | Byte Disable to High Z | | 6 | | 7 | | 7 | ns |
| Write Cycle^[8, 9] | | | | | | | | |
| t_{WC} | Write Cycle Time | 12 | | 15 | | 17 | | ns |
| t_{SCE} | \overline{CE} LOW to Write End | 10 | | 12 | | 14 | | ns |
| t_{AW} | Address Set-Up to Write End | 10 | | 12 | | 14 | | ns |
| t_{HA} | Address Hold from Write End | 0 | | 0 | | 0 | | ns |
| t_{SA} | Address Set-Up to Write Start | 0 | | 0 | | 0 | | ns |
| t_{PWE} | \overline{WE} Pulse Width | 10 | | 12 | | 14 | | ns |
| t_{SD} | Data Set-Up to Write End | 7 | | 8 | | 8 | | ns |
| t_{HD} | Data Hold from Write End | 0 | | 0 | | 0 | | ns |
| t_{LZWE} | \overline{WE} HIGH to Low Z ^[7] | 3 | | 3 | | 3 | | ns |
| t_{HZWE} | \overline{WE} LOW to High Z ^[6, 7] | | 6 | | 7 | | 7 | ns |
| t_{BW} | Byte Enable to End of Write | 10 | | 12 | | 12 | | ns |

Notes:

- Test conditions assume signal transition time of 3 ns or less, timing reference levels of 1.5V, input pulse levels of 0 to 3.0V, and output loading of the specified I_{OL}/I_{OH} and 30-pF load capacitance.
- This part has a voltage regulator which steps down the voltage from 5V to 3.3V internally. t_{power} time has to be provided initially before a read/write operation is started.
- t_{HZOE} , t_{HZCE} , and t_{HZWE} are specified with a load capacitance of 5 pF as in part (b) of AC Test Loads. Transition is measured ± 500 mV from steady-state voltage.
- At any given temperature and voltage condition, t_{HZCE} is less than t_{LZCE} , t_{HZOE} is less than t_{LZOE} , and t_{HZWE} is less than t_{LZWE} for any given device.
- The internal write time of the memory is defined by the overlap of \overline{CE} LOW, and \overline{WE} LOW. \overline{CE} and \overline{WE} must be LOW to initiate a write, and the transition of either of these signals can terminate the write. The input data set-up and hold timing should be referenced to the leading edge of the signal that terminates the write.
- The minimum write cycle time for Write Cycle no. 3 (\overline{WE} controlled, \overline{OE} LOW) is the sum of t_{HZWE} and t_{SD} .

Switching Characteristics^[4] Over the Operating Range (continued)

| Parameter | Description | 7C1041B-20 | | 7C1041B-25 | | Unit |
|-------------------------------------|---|------------|------|------------|------|---------|
| | | Min. | Max. | Min. | Max. | |
| Read Cycle | | | | | | |
| t_{power} | V_{CC} (typical) to the First Access ^[5] | 1 | | 1 | | μ s |
| t_{RC} | Read Cycle Time | 20 | | 25 | | ns |
| t_{AA} | Address to Data Valid | | 20 | | 25 | ns |
| t_{OHA} | Data Hold from Address Change | 3 | | 5 | | ns |
| t_{ACE} | \overline{CE} LOW to Data Valid | | 20 | | 25 | ns |
| t_{DOE} | \overline{OE} LOW to Data Valid | | 8 | | 10 | ns |
| t_{LZOE} | \overline{OE} LOW to Low Z | 0 | | 0 | | ns |
| t_{HZOE} | \overline{OE} HIGH to High Z ^[6, 7] | | 8 | | 10 | ns |
| t_{LZCE} | \overline{CE} LOW to Low Z ^[7] | 3 | | 5 | | ns |
| t_{HZCE} | \overline{CE} HIGH to High Z ^[6, 7] | | 8 | | 10 | ns |
| t_{PU} | \overline{CE} LOW to Power-Up | 0 | | 0 | | ns |
| t_{PD} | \overline{CE} HIGH to Power-Down | | 20 | | 25 | ns |
| t_{DBE} | Byte Enable to Data Valid | | 8 | | 10 | ns |
| t_{LZBE} | Byte Enable to Low Z | 0 | | 0 | | ns |
| t_{HZBE} | Byte Disable to High Z | | 8 | | 10 | ns |
| WRITE CYCLE^[8, 9] | | | | | | |
| t_{WC} | Write Cycle Time | 20 | | 25 | | ns |
| t_{SCE} | \overline{CE} LOW to Write End | 13 | | 15 | | ns |
| t_{AW} | Address Set-Up to Write End | 13 | | 15 | | ns |
| t_{HA} | Address Hold from Write End | 0 | | 0 | | ns |
| t_{SA} | Address Set-Up to Write Start | 0 | | 0 | | ns |
| t_{PWE} | \overline{WE} Pulse Width | 13 | | 15 | | ns |
| t_{SD} | Data Set-Up to Write End | 9 | | 10 | | ns |
| t_{HD} | Data Hold from Write End | 0 | | 0 | | ns |
| t_{LZWE} | \overline{WE} HIGH to Low Z ^[7] | 3 | | 5 | | ns |
| t_{HZWE} | \overline{WE} LOW to High Z ^[6, 7] | | 8 | | 10 | ns |
| t_{EW} | Byte Enable to End of Write | 13 | | 15 | | ns |

Data Retention Characteristics Over the Operating Range (L version only)

| Parameter | Description | | | Conditions ^[11] | Min. | Max. | Unit |
|-----------------|--------------------------------------|-------|---|--|----------|------|------|
| V_{DR} | V_{CC} for Data Retention | | | | 2.0 | | V |
| I_{CCDR} | Data Retention Current | Com'l | L | $V_{CC} = V_{DR} = 3.0V$, $CE \geq V_{CC} - 0.3V$, $V_{IN} \geq V_{CC} - 0.3V$ or $V_{IN} \leq 0.3V$ | | 200 | mA |
| $t_{CDR}^{[3]}$ | Chip Deselect to Data Retention Time | | | | 0 | | ns |
| $t_R^{[10]}$ | Operation Recovery Time | | | | t_{RC} | | ns |

Notes:

10. $t_r \leq 3$ ns for the -12 and -15 speeds. $t_r \leq 5$ ns for the -20 and slower speeds.

11. No input may exceed $V_{CC} + 0.5V$.

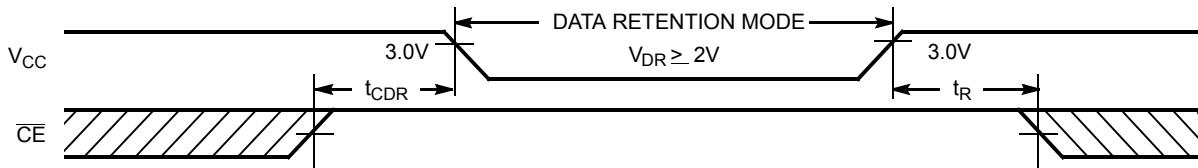
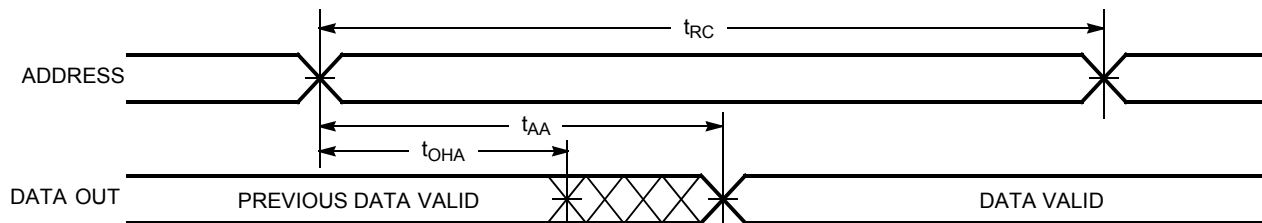
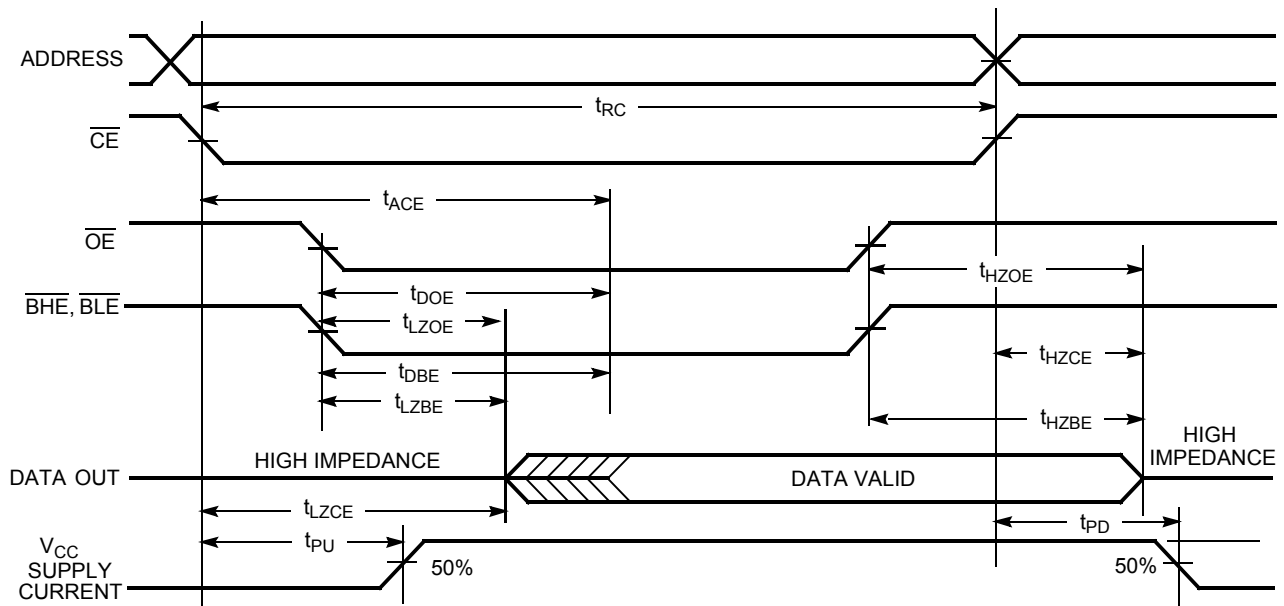
Data Retention Waveform

Switching Waveforms
Read Cycle No. 1^[12, 13]

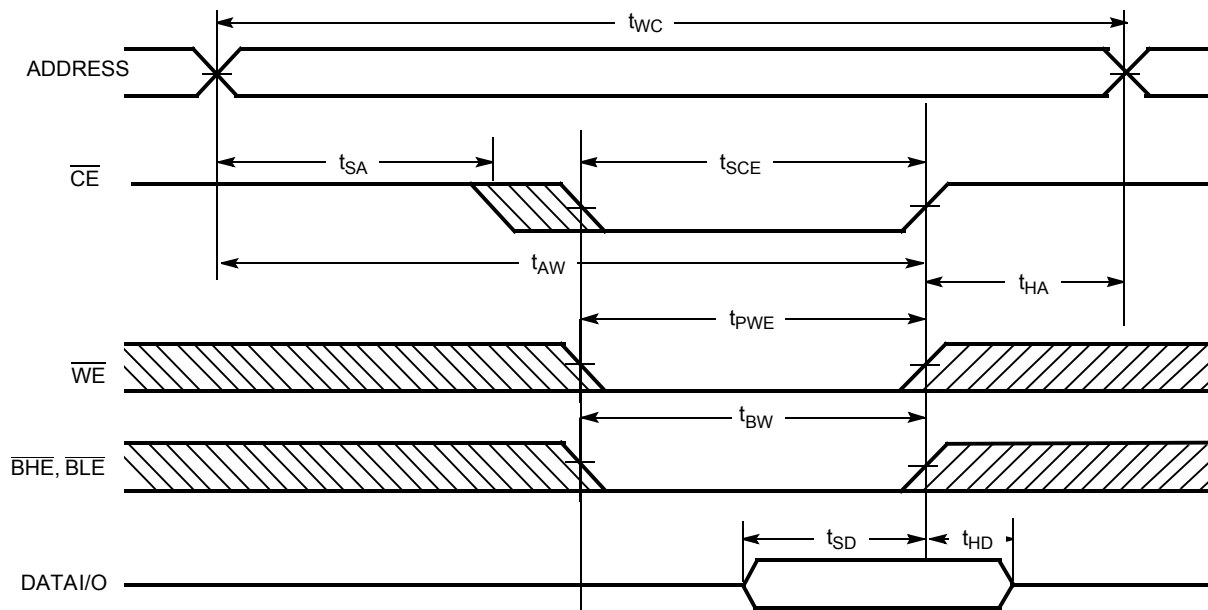
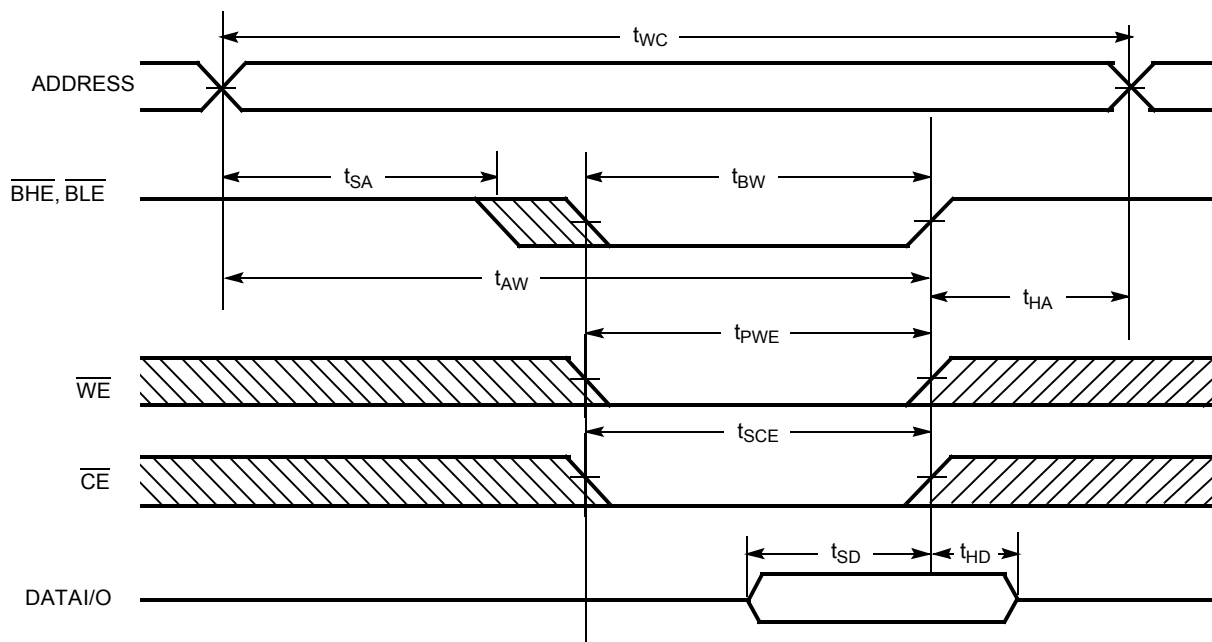
Read Cycle No. 2 (\overline{OE} Controlled)^[13, 14]

Notes:

12. Device is continuously selected. \overline{OE} , \overline{CE} , \overline{BHE} , and/or \overline{BLE} = V_{IL} .
13. WE is HIGH for read cycle.
14. Address valid prior to or coincident with \overline{CE} transition LOW.

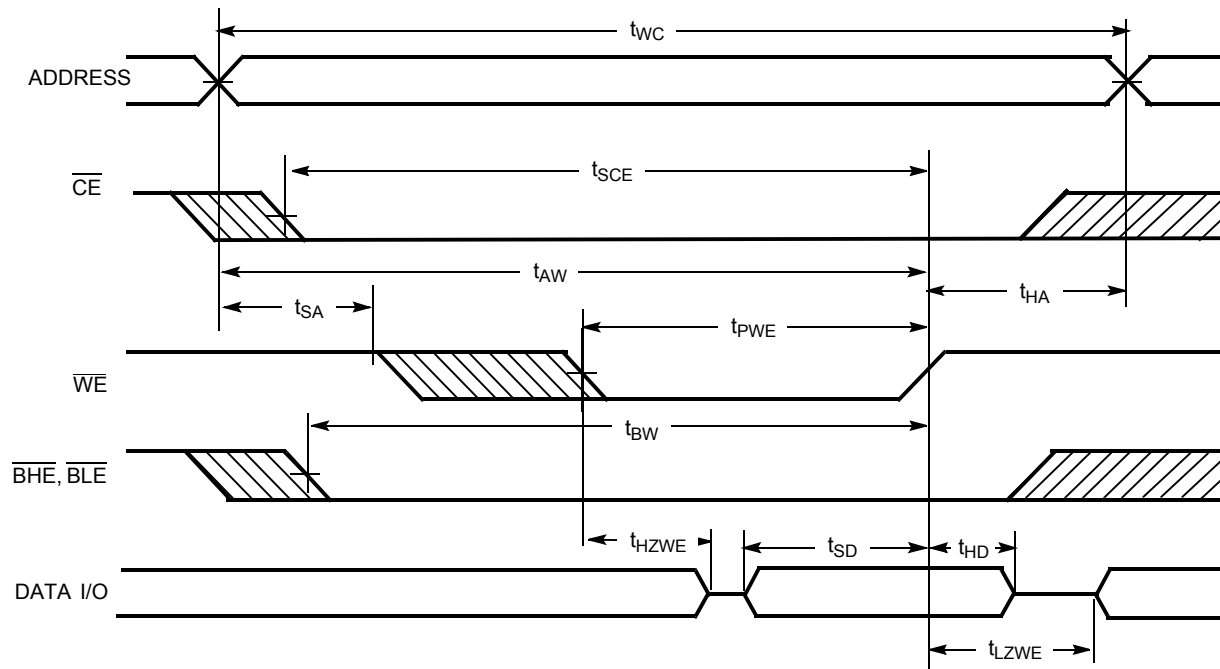
Switching Waveforms (continued)
Write Cycle No. 1 ($\overline{\text{CE}}$ Controlled)^[15, 16]

Write Cycle No. 2 ($\overline{\text{BLE}}$ or $\overline{\text{BHE}}$ Controlled)

Notes:

15. Data I/O is high impedance if $\overline{\text{OE}}$ or $\overline{\text{BHE}}$ and/or $\overline{\text{BLE}} = V_{\text{IH}}$.
16. If $\overline{\text{CE}}$ goes HIGH simultaneously with $\overline{\text{WE}}$ going HIGH, the output remains in a high-impedance state.

Switching Waveforms (continued)

Write Cycle No. 3 (\overline{WE} Controlled, \overline{OE} LOW)

Truth Table

| CE | OE | WE | BLE | BHE | I/O ₀ -I/O ₇ | I/O ₈ -I/O ₁₅ | Mode | Power |
|----|----|----|-----|-----|------------------------------------|-------------------------------------|----------------------------|----------------------|
| H | X | X | X | X | High Z | High Z | Power Down | Standby (I_{SB}) |
| L | L | H | L | L | Data Out | Data Out | Read All bits | Active (I_{CC}) |
| L | L | H | L | H | Data Out | High Z | Read Lower bits only | Active (I_{CC}) |
| L | L | H | H | L | High Z | Data Out | Read Upper bits only | Active (I_{CC}) |
| L | X | L | L | L | Data In | Data In | Write All bits | Active (I_{CC}) |
| L | X | L | L | H | Data In | High Z | Write Lower bits only | Active (I_{CC}) |
| L | X | L | H | L | High Z | Data In | Write Upper bits only | Active (I_{CC}) |
| L | H | H | X | X | High Z | High Z | Selected, Outputs Disabled | Active (I_{CC}) |

Ordering Information

| Speed (ns) | Ordering Code | Package Name | Package Type | Operating Range |
|------------|------------------|--------------|--|-----------------|
| 12 | CY7C1041B-12VC | V34 | 44-Lead (400-Mil) Molded SOJ | Commercial |
| | CY7C1041B-12VXC | V34 | 44-Lead (400-Mil) Molded SOJ (Pb-free) | |
| | CY7C1041B-12ZC | Z44 | 44-Lead TSOP Type II | |
| | CY7C1041B-12ZXC | Z44 | 44-Lead TSOP Type II (Pb-free) | |
| 15 | CY7C1041B-15VC | V34 | 44-Lead (400-Mil) Molded SOJ | |
| | CY7C1041B-15VXC | V34 | 44-Lead (400-Mil) Molded SOJ (Pb-free) | |
| | CY7C1041BL-15VC | V34 | 44-Lead (400-Mil) Molded SOJ | |
| | CY7C1041B-15ZC | Z44 | 44-Lead TSOP Type II | |
| | CY7C1041B-15ZXC | Z44 | 44-Lead TSOP Type II (Pb-free) | |
| | CY7C1041BL-15ZC | Z44 | 44-Lead TSOP Type II | |
| | CY7C1041BL-15ZXC | Z44 | 44-Lead TSOP Type II (Pb-free) | |
| 17 | CY7C1041B-17VC | V34 | 44-Lead (400-Mil) Molded SOJ | |
| | CY7C1041BL-17VC | V34 | 44-Lead (400-Mil) Molded SOJ | |
| | CY7C1041B-17ZC | Z44 | 44-Lead TSOP Type II | |
| | CY7C1041BL-17ZC | Z44 | 44-Lead TSOP Type II | |
| 20 | CY7C1041B-20VC | V34 | 44-Lead (400-Mil) Molded SOJ | |
| | CY7C1041B-20VXC | V34 | 44-Lead (400-Mil) Molded SOJ (Pb-free) | |
| | CY7C1041BL-20VC | V34 | 44-Lead (400-Mil) Molded SOJ | |
| | CY7C1041BL-20VXC | V34 | 44-Lead (400-Mil) Molded SOJ (Pb-free) | |
| | CY7C1041B-20ZC | Z44 | 44-Lead TSOP Type II | |
| | CY7C1041B-20ZXC | Z44 | 44-Lead TSOP Type II (Pb-free) | |
| | CY7C1041BL-20ZC | Z44 | 44-Lead TSOP Type II | |
| 25 | CY7C1041B-25VC | V34 | 44-Lead (400-Mil) Molded SOJ | |
| | CY7C1041BL-25VC | V34 | 44-Lead (400-Mil) Molded SOJ | |
| | CY7C1041B-25ZC | Z44 | 44-Lead TSOP Type II | |
| | CY7C1041BL-25ZC | Z44 | 44-Lead TSOP Type II | |
| 15 | CY7C1041B-15ZI | Z44 | 44-Lead TSOP Type II | Industrial |
| | CY7C1041B-15ZXI | Z44 | 44-Lead TSOP Type II (Pb-free) | |
| | CY7C1041B-15VI | V34 | 44-Lead (400-Mil) Molded SOJ | |
| | CY7C1041B-15VXI | V34 | 44-Lead (400-Mil) Molded SOJ (Pb-free) | |
| 17 | CY7C1041B-17ZI | V34 | 44-Lead TSOP Type II | |
| | CY7C1041B-17VI | Z44 | 44-Lead (400-Mil) Molded SOJ | |
| 20 | CY7C1041B-20ZI | Z44 | 44-Lead TSOP Type II | |
| | CY7C1041B-20ZXI | Z44 | 44-Lead TSOP Type II (Pb-free) | |
| | CY7C1041B-20VI | Z44 | 44-Lead (400-Mil) Molded SOJ | |
| | CY7C1041B-20VXI | Z44 | 44-Lead (400-Mil) Molded SOJ (Pb-free) | |
| 25 | CY7C1041B-25ZI | Z44 | 44-Lead TSOP Type II | |
| | CY7C1041B-25VI | Z44 | 44-Lead (400-Mil) Molded SOJ | |

Package Diagrams

44-Lead (400-Mil) Molded SOJ V34

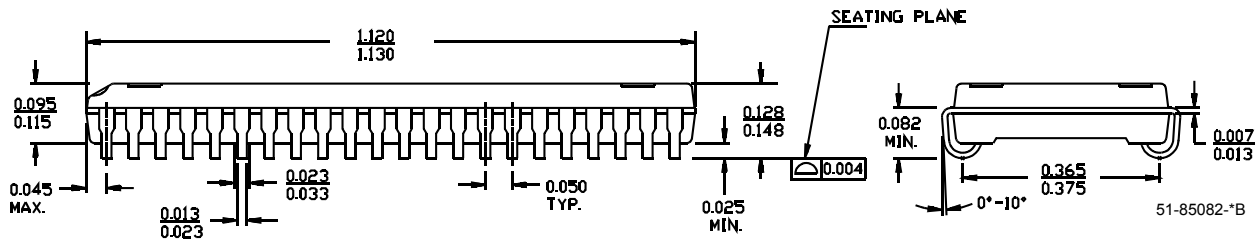
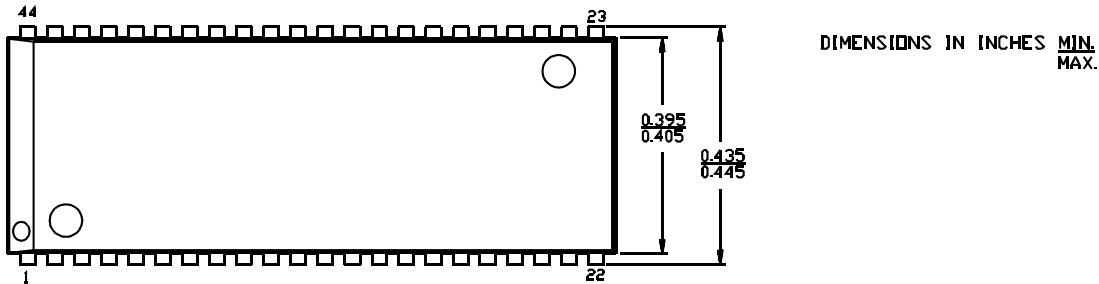

44-Pin TSOP II Z44

DIMENSION IN MM (INCH)
MAX
MIN.

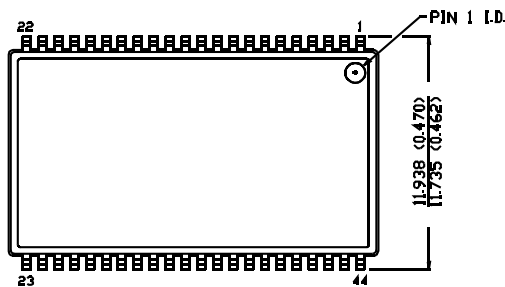

TOP VIEW

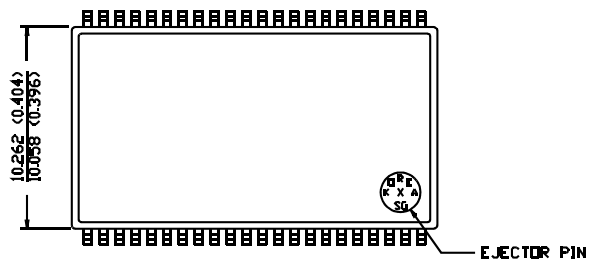

BOTTOM VIEW

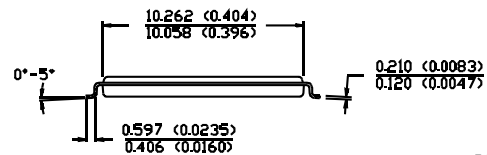
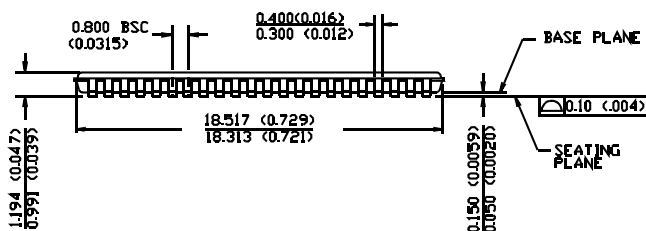

All products and company names mentioned in this document may be the trademarks of their respective holders.

Document History Page

| Document Title: CY7C1041B 256K x 16 Static RAM Document Number: 38-05142 | | | | |
|---|----------------|-------------------|------------------------|---|
| REV. | ECN NO. | Issue Date | Orig. of Change | Description of Change |
| ** | 109886 | 09/15/01 | SZV | Change from Spec number: 38-00938 to 38-05142 |
| *A | 341401 | See ECN | AJU | Added Pb-free ordering information |